



OMNI-404 User Guide

South Africa

Unit 4, N1 Industrial Park
Landmarks Ave
Samrand, 0157,
South Africa
Tel: +27 12 657 0050
info@poynting.tech

Europe

Kronstadler Straße 4,
81677 München
Germany
Tel: +49 89 2080 265 38
Mob.: +49 176 529 733 50
sales-europe@poynting.tech

1.	Packing Check List	4
2.	Optional Accessories	6
3.	Introduction	7
4.	Installation Instructions	8
5.	Antenna Mounting Precautions	9
6.	Cable Routing	9
7.	Safety	10

1 Packing Check List

Item	Description	Quantity
1.	A-OMNI-0404 Antenna only	1
2.	M4 Allen Cap screws	4
3.	3mm Allen Key	1
4.	Adapter Base	1
5.	Seal	1
6.	Locking nut	1

The appearance of each component

Antenna Unit

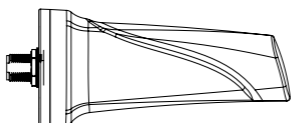

Adapter Base and Seal

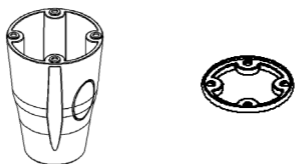

Allen cap screw and locking nut



3mm Allen key



Optional Accessories

A-BRKT-037: Marine flat mount antenna bracket stainless steel

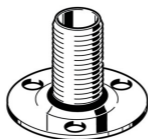

AA-BRKT-038: Marine ratchet rail mount antenna bracket stainless steel

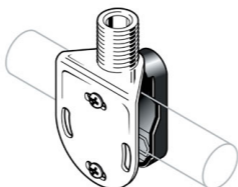

A-BRKT-039: Heavy duty marine mount antenna bracket stainless steel

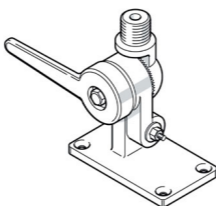

This User Guide provides information on the installation instructions of the Omni-directional marine antenna (A-OMNI-0404)

Antenna Configuration 1

Pole mount with optional L-Bracket

Exploded View

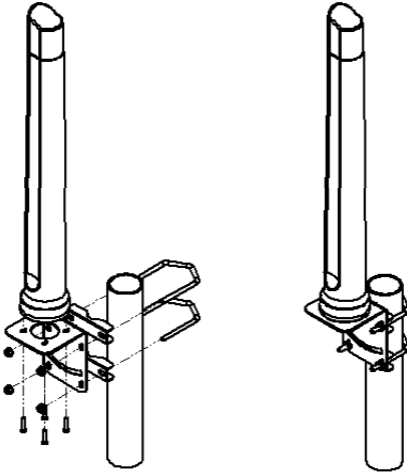

Antenna Configuration 2

Marine mount with optional bracketry using the provided allen key.

Exploded View

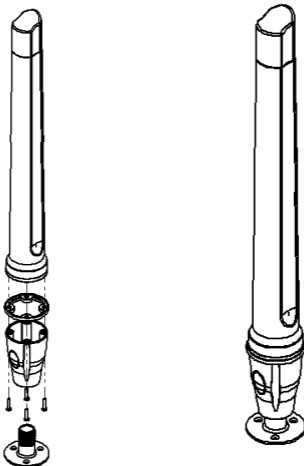

- Open the antenna package and confirm that all listed components are available.
- Consider the antenna mounting precautions below before installation.

Straight cable entry

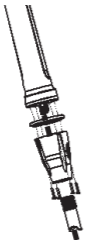

Slide the RF cable through the bracket pipe, seal and adapter base. Fasten the adapter base to the antenna using the provided allen key.



Assembled antenna with straight entry cable.

Side cable entry

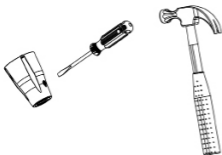

Use a flat screw driver on the knock out edge of the adapter base to break the knock out section as shown above. A file might be required to remove sharp edges.



Assembled antenna with side entry cable.

5

Antenna Mounting Precautions

- Place the antenna at the highest point of the vessel and ensure that there aren't any surrounding obstructions to the antenna.
- In order to avoid communication interference, ensure that the antenna is placed at least 0.5m away from other antennas and metal objects.
- Avoid installing the antenna near the vessel's chimney, as the smoke and soot emitted by the chimney can obstruct the signal level achieved by the antenna.
- Install the antenna away from the vessel's heat sources and flammable gases.

6

Cable Routing

- Survey the planned cable route and look for any blocked passages. Consider alternate routes to find the best available path. Always keep the cables as short as possible to make sure that minimum cable losses are achieved.
- **Note:** Take advantage of any existing cable channels. e.g wiring conduits to route the cables.
- Avoid running cables through components or sharp apertures that may cause excessive chafing. Doing so may erode the jacket and break signal continuity. Also, avoid kinking, pinching, or twisting a cable during a run.

- Use cable ties to secure the antenna cables. **When handling the antenna cables, it is essential you follow these basic rules:**
 - Never pull on the cable connectors; pull only on the cable.
 - Never run cables in a manner that interferes with the driver's ability to safely operate the boat.
 - Tighten the connectors and ensure that the cables don't rattle loose.

7

Safety

- The antenna may not be used as a climbing or pulling device.
- Considerations must be taken when mounting the antenna that people do not hang or pull on it.
- Use safety goggles when drilling the antenna hole.
- Avoid using bits that are dull, bent or damaged.
- Be aware of where your fingers are in relation to the drill bit when using the drilling machine.
- To stop the drilling machine, let the drill chuck come to a complete stop on its own. Never grasp the chuck in an attempt to stop the drill bit.
- Avoid operating while under the influence of drugs, alcohol or medication.
- Make sure that any loose fitting jewellery or clothing is secured and tie back long hair as they can get caught in moving parts during installation.
- Avoid awkward hand positions where a sudden slip could cause a hand to move into the drill bit or cutting tool.